

MODEL:RA-DC5015

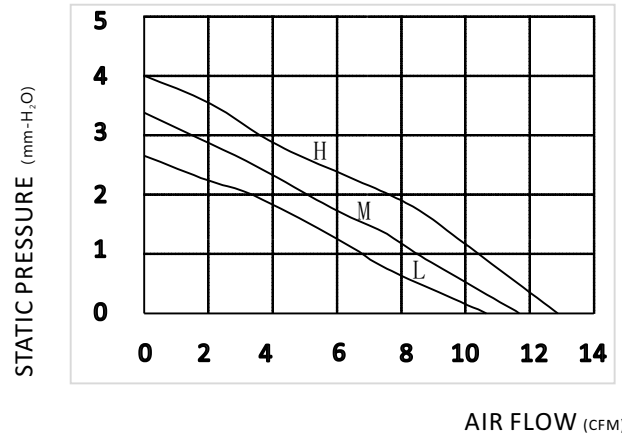

SPECIFICATION

(L: Low -speed; M: Middle - speed; H: High -speed; U: Ultra high-speed; D: Ultra low-speed)

Voltage (VDC)	Model	Current	Power	Speed	Max air-flow		Max Pstatic	Noise
		A	W	RPM	CMH	CFM	mm-H ₂ O	DbA
12	L	0.10	1.20	4500	2.21	10.64	2.64	31
	M	0.12	1.44	5000	3.25	11.67	3.37	33
	H	0.15	1.80	5500	4.79	12.88	4.00	36
24	L	0.05	1.20	4500	2.21	10.64	2.64	31
	M	0.06	1.44	5000	3.25	11.67	3.37	33
	H	0.07	1.68	5500	4.79	12.88	4.00	36

DRAWING

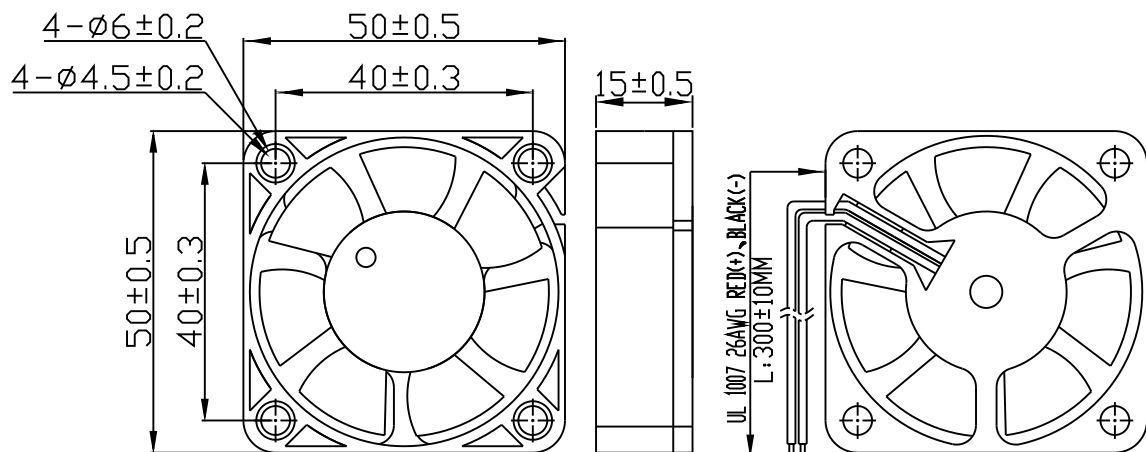

GENERAL DESCRIPTION

1. BEARING TYPE: BALL BEARING OR SLEEVE
2. IMPELLER AND FRAM MATERIAL: PBT
3. MOTOR TYPE: BLDC
4. INSULATION GRADE: E
5. INSULATION RESISTANCE: 10M/500VDC
6. DIELECTRIC STRENGTH: 2MINIMUM/500AVC-5mA
7. AMBIENT HUMIDITY: RH20%-RH75%
8. STORAGE TEMPERATURE: -20°C ~ +75°C
9. WORKING TEMPERATURE: -10°C ~ +70°
10. SERVICE LIFE: 50000 HRS

CUSTOMIZATION FUCTIONS

➤ PWM; Vsp; SOFT-START; CLOSED-LOOP; GAPCYCLE RUNNING

OUT SIGNAL

➤ FG; RD (EXCEED THE MIN. SPEED SETTINGS)

PROTECTION

➤ LOCKED; WATER-PROOF; DUSTY-PROOF